

LUMO-S

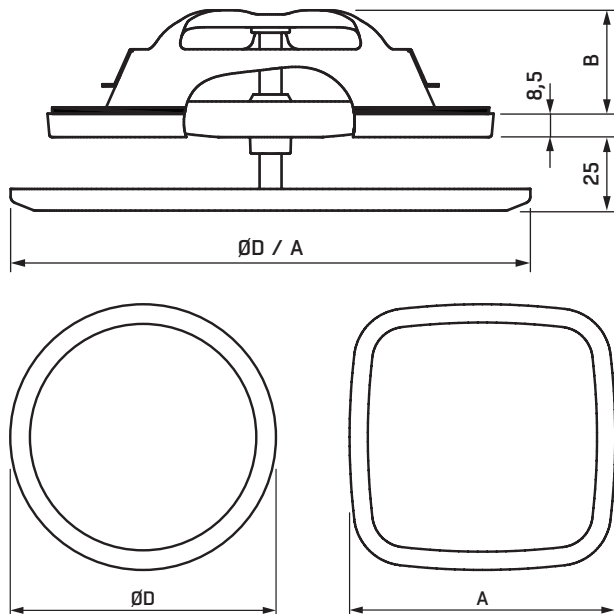

LUMO-R

LUMO



LUMO	ØD	A	B
100	145	145	32
125	185	185	38
160	215	215	42
200	270	270	53

KKT, KKL

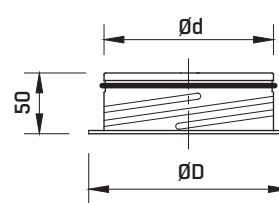

KKU

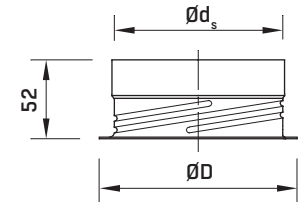

KKT/KKL/KKU	Ød	ØD	Ød <sub>s</sub>
100	99	122	100
125	124	148	125
160	159	184	160
200	199	225	200

KGEZ-01

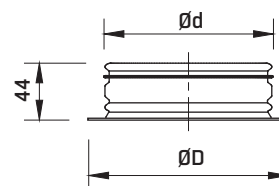

KGEZ-01	Ød	ØD
100	99	123
125	124	149
160	159	185

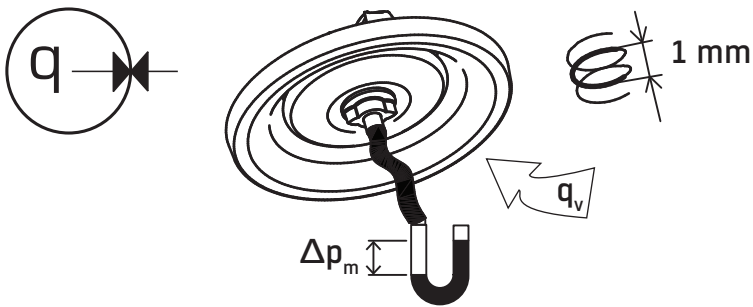
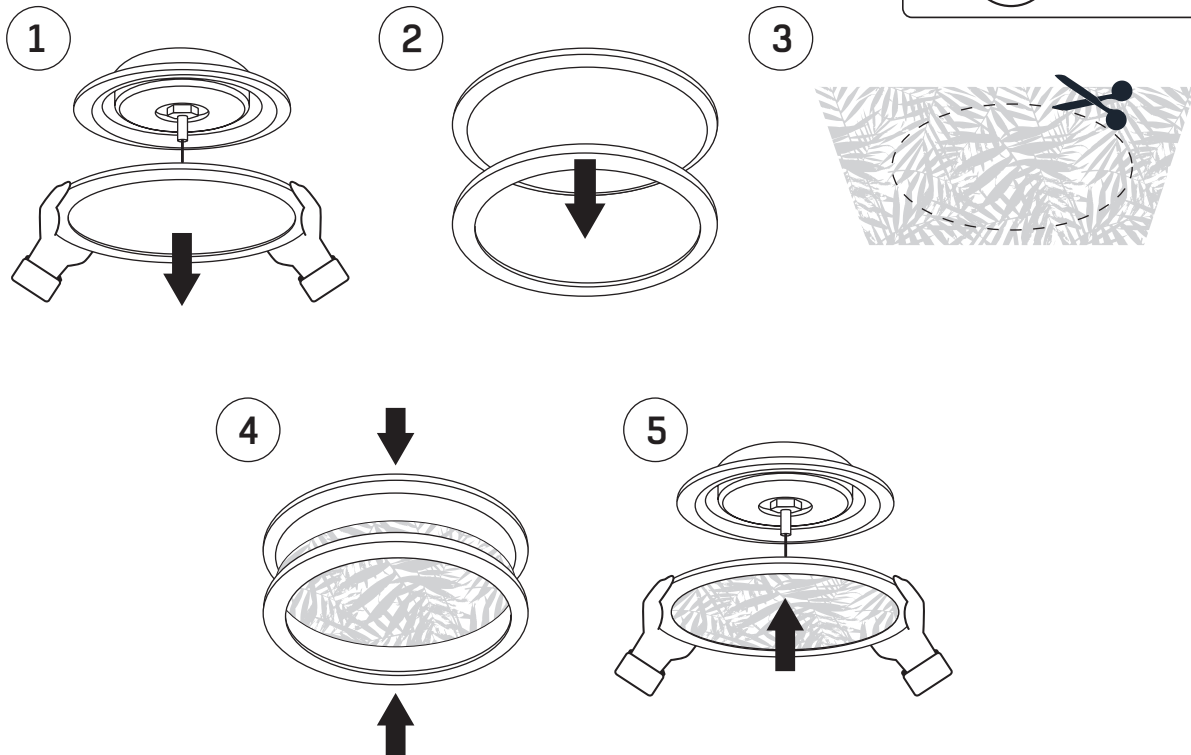
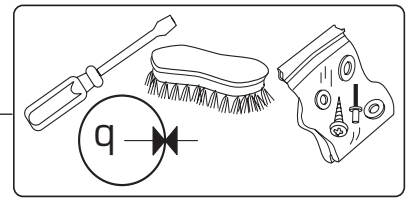

$$q = k \sqrt{\Delta p_m}$$

(l/s) (Pa)

$$q = 3.6k \sqrt{\Delta p_m}$$

(m³/h) (Pa)

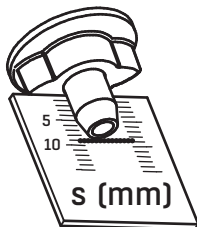
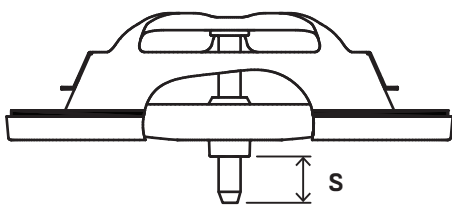

LUMO-100	
s (mm)	k
26	0.36
25	0.45
24	0.56
23	0.69
22	0.83
21	0.98
20	1.14
19	1.30
18	1.47
17	1.65
16	1.82
15	1.99
14	2.16
13	2.33
12	2.49
11	2.64
10	2.77
9	2.90
8	3.01
7	3.10
6	3.17
5	3.23
4	3.26

LUMO-125	
s (mm)	k
32	0.75
31	0.91
30	1.06
29	1.23
28	1.39
27	1.56
26	1.74
25	1.91
24	2.09
23	2.28
22	2.46
21	2.65
20	2.85
19	3.04
18	3.24
17	3.45
16	3.65
15	3.87
14	4.08
13	4.30
12	4.52
11	4.74
10	4.97
9	5.20
8	5.43
7	5.67

LUMO-160	
s (mm)	k
34	1.67
33	1.84
32	2.02
31	2.19
30	2.38
29	2.57
28	2.76
27	2.96
26	3.16
25	3.37
24	3.58
23	3.79
22	4.01
21	4.24
20	4.47
19	4.70
18	4.94
17	5.18
16	5.43
15	5.68
14	5.94
13	6.20
12	6.47
11	6.74
10	7.02
9	7.30
8	7.58
7	7.87

LUMO-200	
s (mm)	k
41	1.85
40	2.09
39	2.33
38	2.58
37	2.83
36	3.09
35	3.35
34	3.61
33	3.88
32	4.15
31	4.43
30	4.71
29	4.99
28	5.28
27	5.57
26	5.86
25	6.16
24	6.46
23	6.77
22	7.08
21	7.39
20	7.71
19	8.03
18	8.35
17	8.68
16	9.02
15	9.35
14	9.69
13	10.04
12	10.38
11	10.73
10	11.09
9	11.45
8	11.81
7	12.18

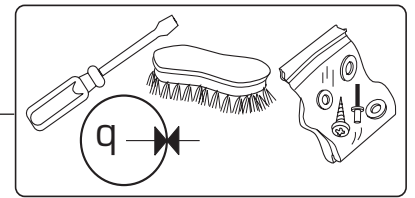

LUMO-100 <sup>1)</sup>

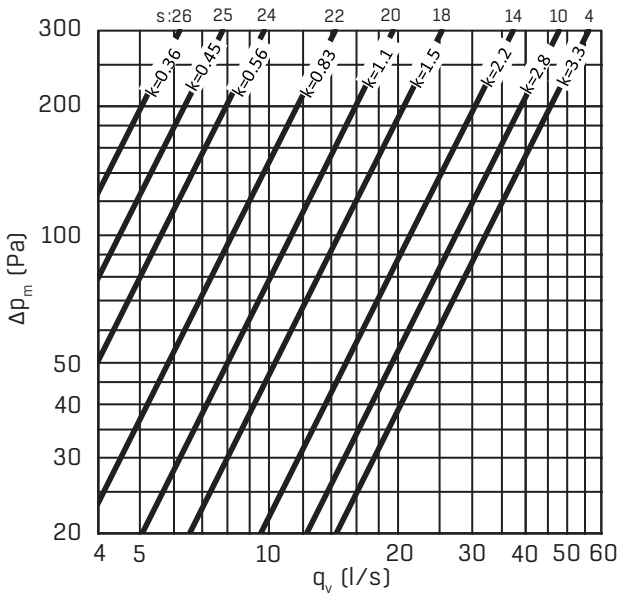

LUMO-125 <sup>1)</sup>

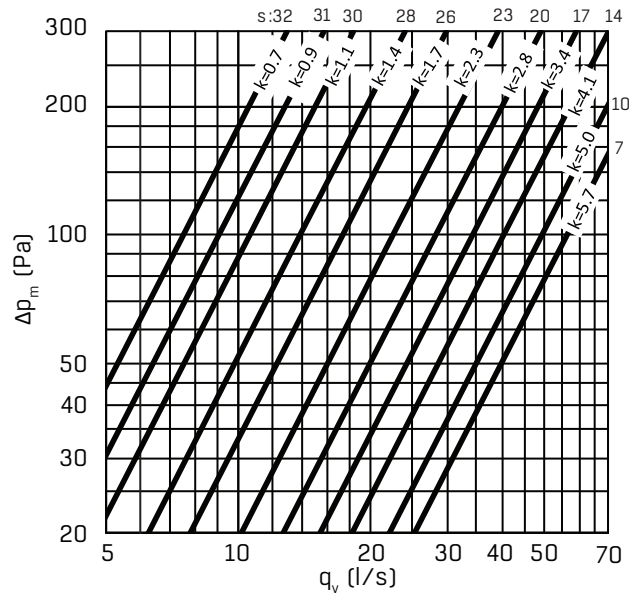

LUMO-160

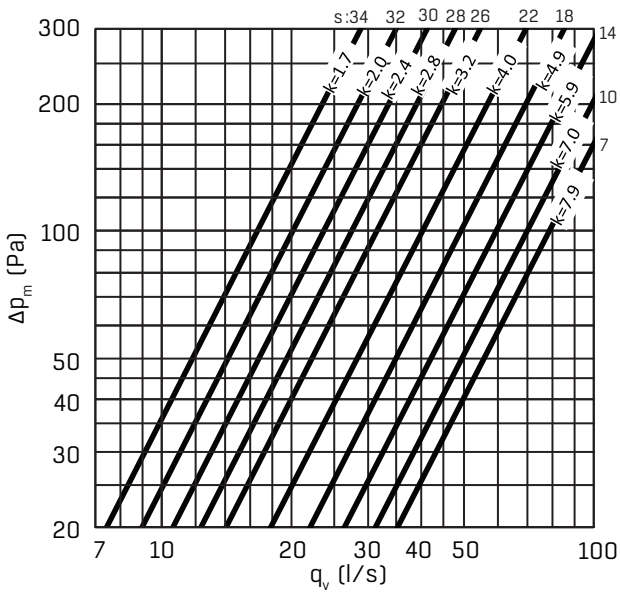

LUMO-200

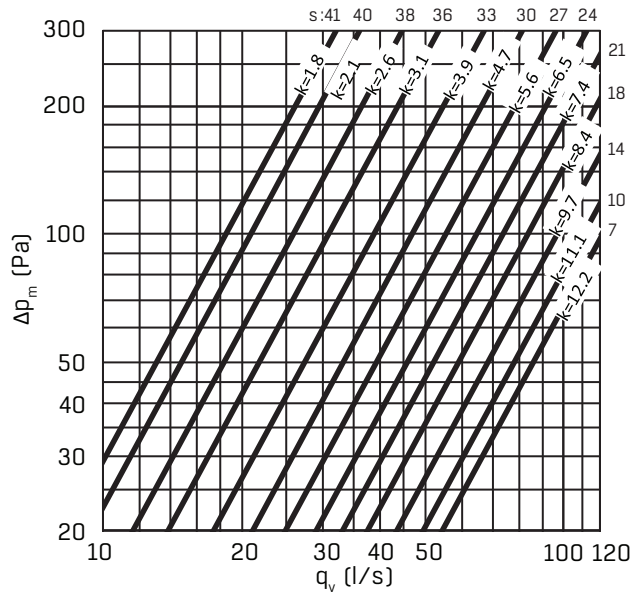

<sup>1)</sup> FI: LUMO koko 100 (kaikki säätöasetnot) ja koko 125 (säätöasetto  $\geq 12$ ) täyttää savukaasujen leviämistä rajoittavalle kuristimelle asetetut vaatimukset.

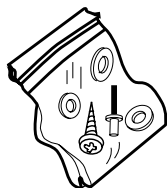
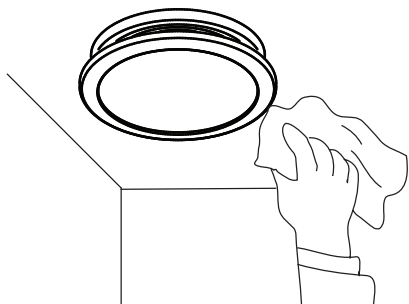
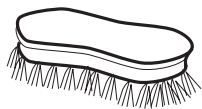
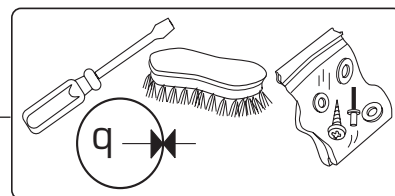

LUMZ-R-aaa-C

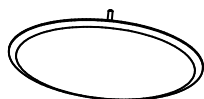

LUMZ-S-aaa-C

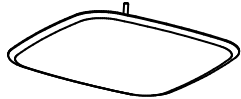

aaa
100
125
160
200

COGZ-aaa-9

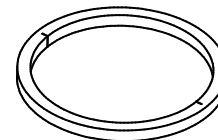
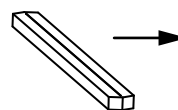

aaa
100
125
160
200

LUMR-aaa



LUMS-aaa



aaa
100
125

COAZ-3

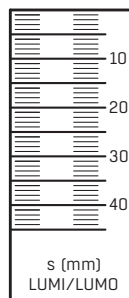

COSZ-aaa-1



aaa
100
125

COCZ-2

