

# TMR20

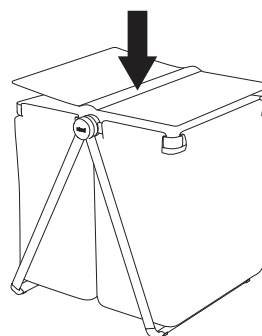
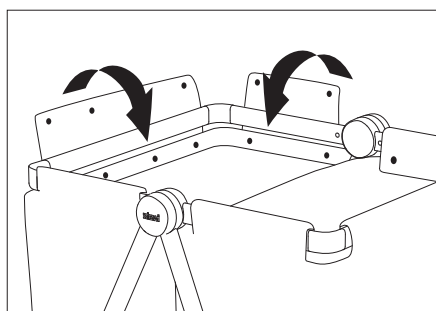
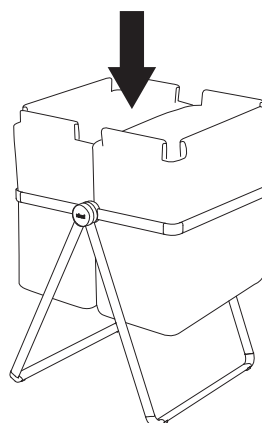
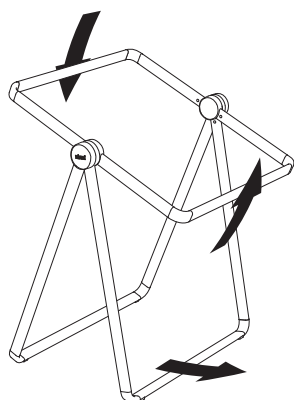
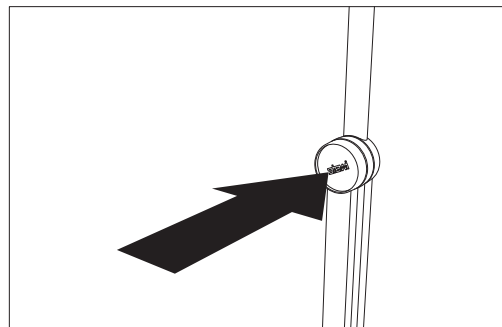
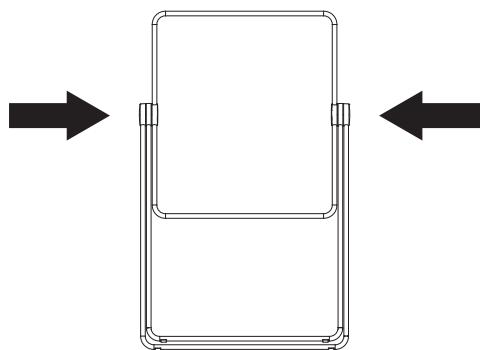

STEWI AG / CH-8404 Winterthur

[www.stewi.com/tomorrow](http://www.stewi.com/tomorrow)