



# **WING**

Air curtain

Catalog





## 01 VTS GROUP

- 1.1 VTS: Manufacturer No. 1 in the world
- 1.2 3 constituents of success

## 02 WING

- 2.1 WING air curtains
- 2.2 Silence and power
- 2.3 Design and performance
- 2.4 Quality and design
- 2.5 Product range
- 2.6 Accessories

## 03 INSTALLATION

- 3.1 Installation
- 3.2 Example of installation
- 3.3 Sample connection diagram for the air curtain

## 04 TECHNICAL PARAMETERS

- 4.1 Technical parameters
- 4.2 Air curtains with water heaters
- 4.3 Ambient Air Curtains
- 4.4 Air Curtains with electric heater

## 05 KNOWLEDGE

- 5.1 FAQ

## 06 VTS OFFER

- 6.1 Check also in VTS offer: Volcano

**VTS GROUP** – The manufacturer of technologically advanced devices for the HVAC industry applying innovative technologies in the field of design research, production and logistics.

## OUR MISSION

**No. 1 MANUFACTURER  
IN THE WORLD**

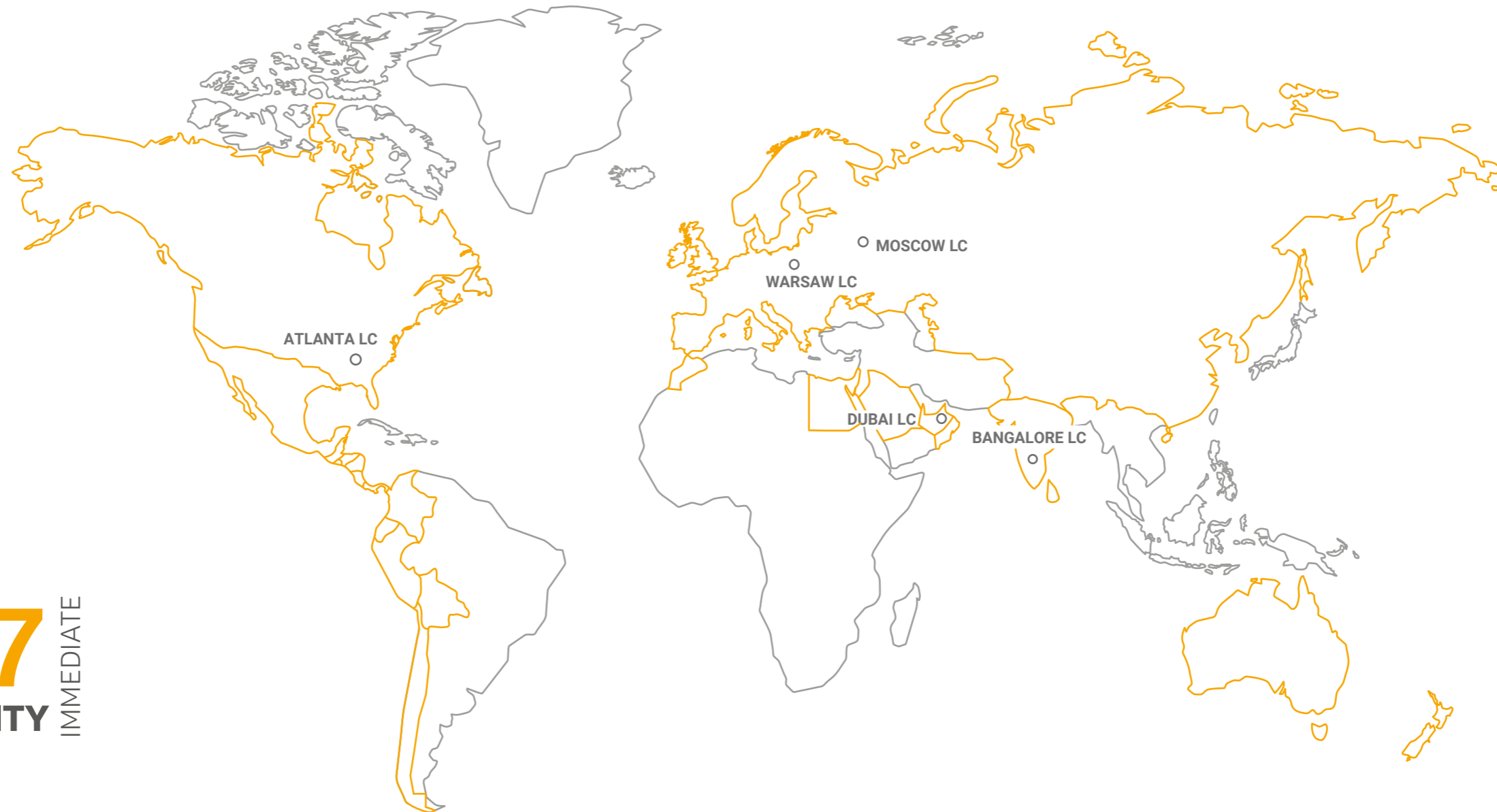

**24/7** IMMEDIATE  
AVAILABILITY

\*-Logistics center





## 3 constituents of success

The highest quality of products. The best prices on the market. The shortest delivery times. These three pillars of our market policy are why VTS is always one step ahead worldwide.

Following the best world practices from the automotive industry, VTS has created a network of 5 efficient production & logistics centers (**Atlanta, Dubai, Moscow, Shanghai, Warsaw, Bangalore**) to guarantee the shortest delivery time on the market, regardless of your location.

Mass production scale of universally repeatable devices allows VTS to offer them **in the most competitive prices, while maintaining the highest quality.**

A multi-level control system allows VTS to offer a **3-year warranty for devices as a standard.**

**24/7** IMMEDIATE  
AVAILABILITY

**5** CENTERS  
LOGISTICS

COMPETITIVE  
**\$ PRICE**

**100 000** SOLD  
UNITS A YEAR

THE HIGHEST  
**QUALITY**

**3** YEARS GUARANTEE  
FOR EACH DEVICE



# WING by VTS

WING is the new generation device created from a passion for a light and modern design representing characteristics of gliders. A minimal casing with a streamlined form of a wing that seems to float in the air. The diamond style side panels hide the excellent components in an innovative curtain body to set new standards for air curtains. WING combines the unique design and excellent efficiency to redefine the air curtain image.



QUIET OPERATION



EFFICIENT AND  
RELIABLE EC MOTORS



BIM COMPATIBLE  
REVIT® FILES



AVAILABLE ONLINE  
24/7



# | Silence and power

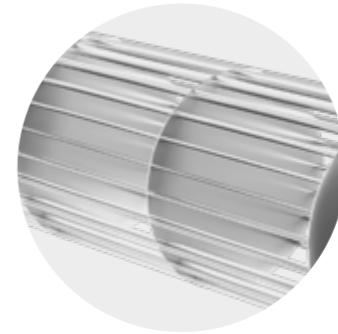
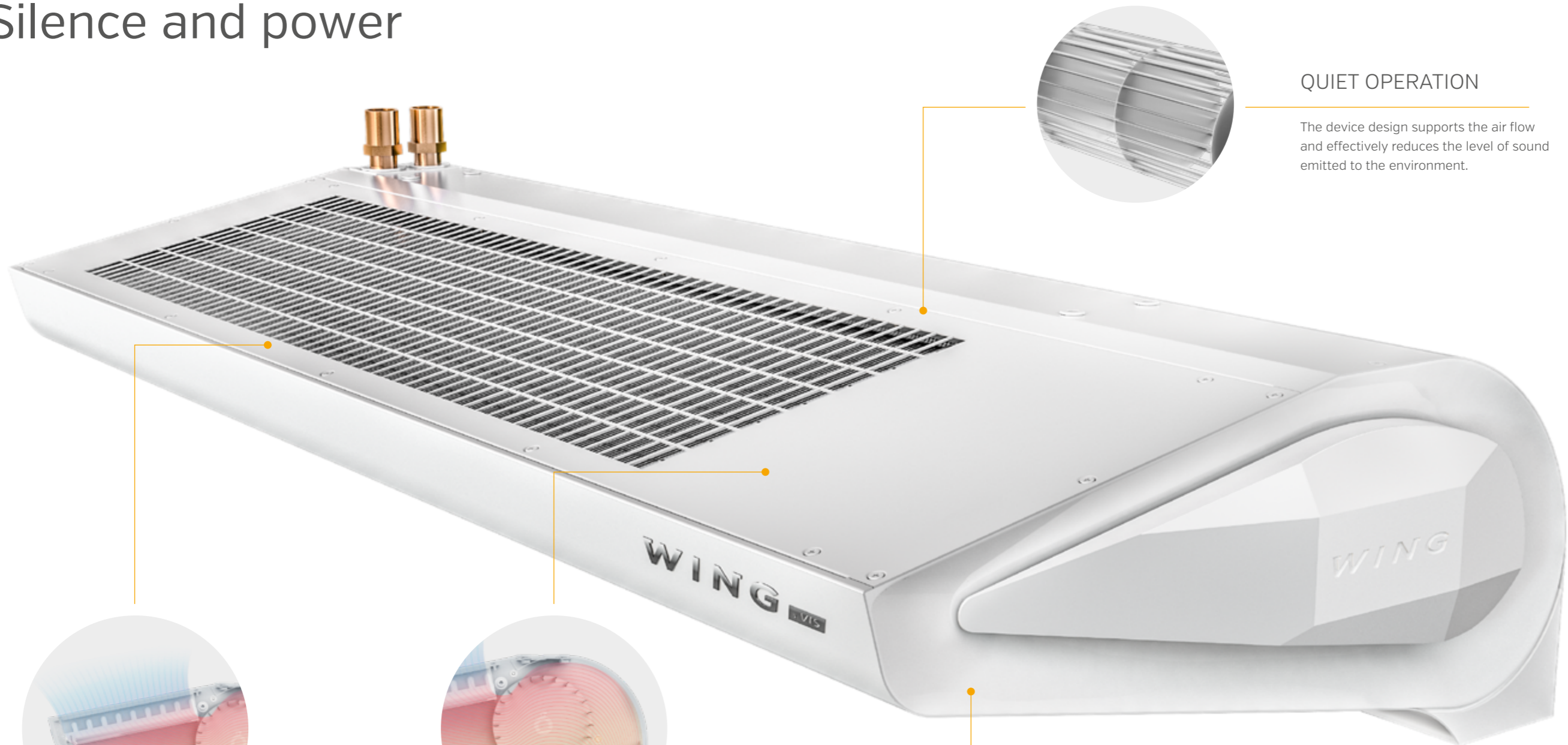

## QUIET OPERATION

The device design supports the air flow and effectively reduces the level of sound emitted to the environment.

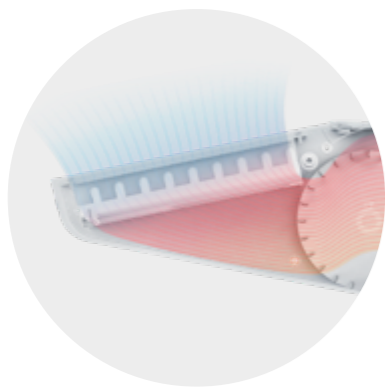

## LOW RESISTANCE OF THE AIR INLET

A larger surface of the air inlet allows the heat exchanger to be fully utilized.



## OPTIMAL AIR FLOW RATE

The special design of the blades ensures an increase in the air stream range by 20% compared to conventional approaches. Larger air intake area makes it possible to take full advantage of heat exchanger power.



## CONFIGURED TO BUILDING SPECIFICATIONS

The Electronically Controlled motor allows an easy adjustment of the Wing to any protected entryway requirements.





# | Design and Performance

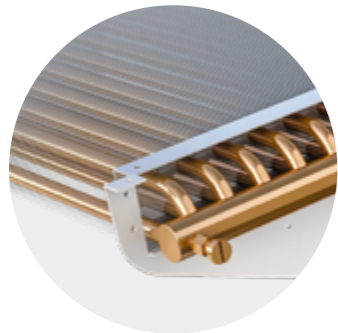

## WATER HEATER

The high-performance, two-row water heater is adapted to operate with low parametric factors.

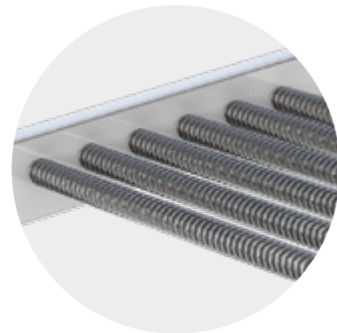

## ELECTRIC HEATER

The low-temperature, high-power heater ensures safe operation without a fan overrun. The asymmetrical distribution of the heating power provides the best adjustment to individual customer needs.

## COMBINATION OF FUNCTIONALITY AND DESIGN

A characteristic diamond-shaped element of the side cover not only protects the inlet of the engine cooling system but also fulfills an inspective function.





# | Quality and design

## ELECTRICITY SAVINGS

Modern design of the engine and fan saves up to 60% of energy compared to conventional solutions.

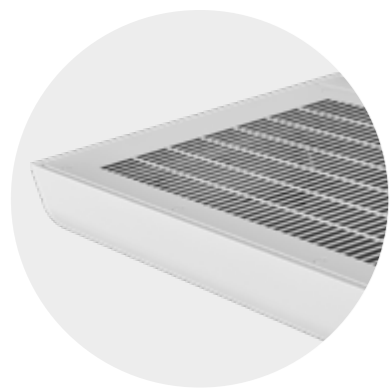
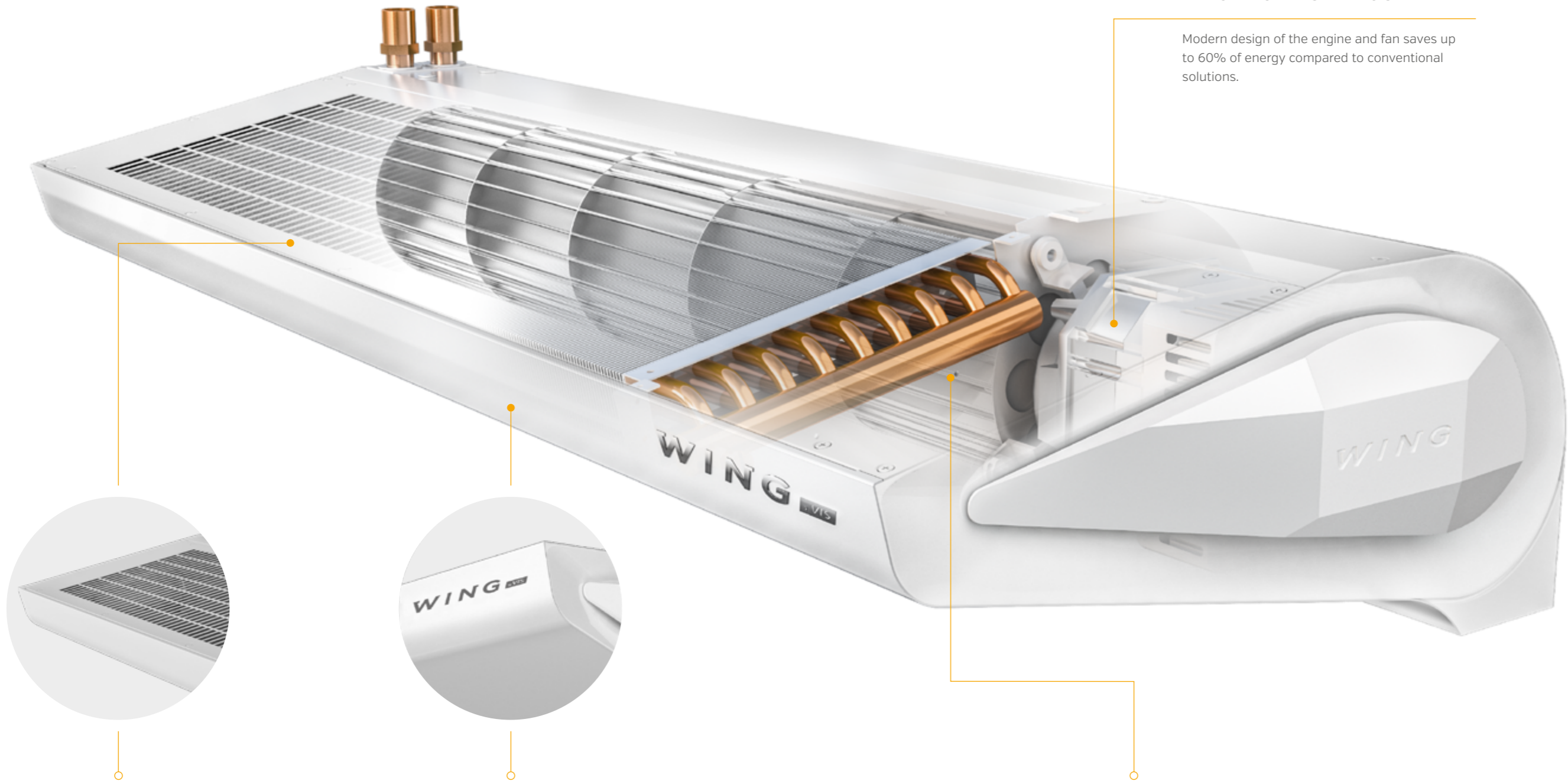

## SIMPLE CLEANING

Thanks to the optimized construction of the covers, cleaning the curtain is comfortable and does not require the disassembly of any part, always ensuring hygienic operation.



## GALVANIZED STEEL CASING

Double coating (galvanization + powder paint) provides long-term protection against corrosion and consistent aesthetic qualities.

## HIGH EFFICIENCY

High power output is a result of applying a heater with large heat exchange surface arranged in a uniform air stream.





# Product range

## WING W

### WATER HEAT EXCHANGER

HEATING POWER RANGE:  
**4 – 47 kW**

EXHAUST FLOW RATE:  
**1850-4400 m<sup>3</sup>/h**

MAXIMUM AIR COVERAGE:  
**3,7 m**

200 W/E/C



150 W/E/C

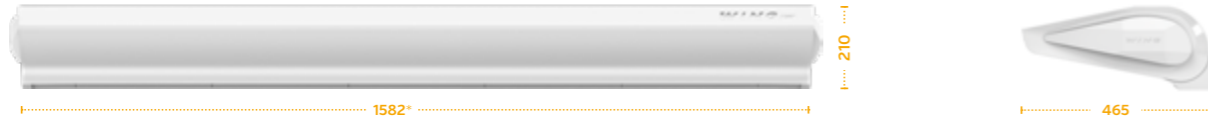

100 W/E/C



\* - width does not include side covers

## WING E

### ELECTRIC HEATER

HEATING POWER RANGE:  
**2 – 15 kW**

EXHAUST FLOW RATE:  
**1850-4500 m<sup>3</sup>/h**

MAXIMUM AIR COVERAGE:  
**3,7 m**

## WING C

### WITHOUT HEAT EXCHANGER [AMBIENT]

EXHAUST FLOW RATE:  
**1950-4600 m<sup>3</sup>/h**

MAXIMUM AIR COVERAGE:  
**4 m**

## STREAM RANGE

Vertical air stream range  
(maximum installation height)

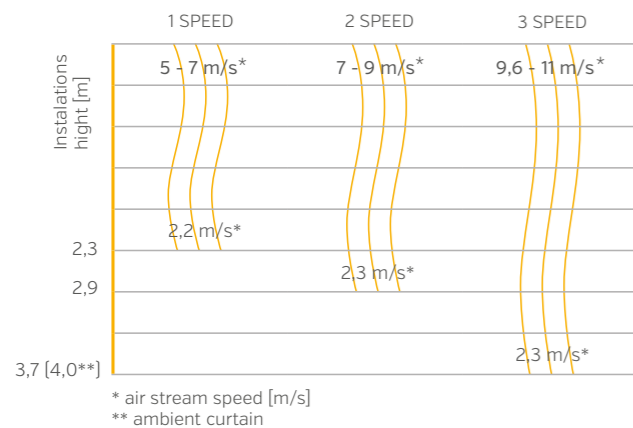

Horizontal air stream range  
(for vertical installation)

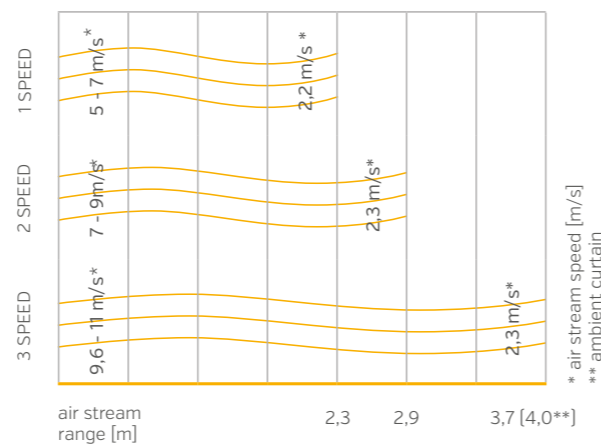

# Accessories

HMI WING EC controller		Wall controller WING/VOLCANO		Door sensor (reed switch)*		Valve with actuator (VA-VEH202TA)	
VTS article No.	1-4-2801-0155	VTS article No.	1-4-0101-0438	VTS article No.	1-4-0101-0454	VTS article No.	1-2-1204-2019
Motor support	EC	Motor support	AC	Contact configuration	NO	Power supply voltage	V/ph/Hz ~230/1/50
Power supply voltage	V/ph/Hz ~230/1/50	Power supply voltage	V/ph/Hz ~230/1/50	Switching current	500 mA	Opening	min 3/3
Permissible load	A 1A for 230VAC, 0,02A for 0-10V	Permissible load	A 6(3)	Switching voltage	max 200 V	Kvs	- 4,5
Setting range	°C 5...40	Setting range	°C 10...30	Connection	screw	Protection rating	IP 54
Protection rating	IP 20	Protection rating	IP 30				

\* cooperations with WING EC controller

## HMI WING EC controller



- modern and compact design
- high contrast and clear screen
- advanced calendar for each day in the week
- door sensor cooperation
- BMS systems compatibility
- preset 3-levels speed control
- built-in thermostat
- 3-levels of heating power
- up to 8 air curtains connected with the one controller

### Door Optimum function

Door Optimum function allows to maintain full protection of the door opening and at the same time optimize costs associated with its operation. It keeps the air curtain operating on minimum speed, and when the doors are going to be open protect the door opening from the first moment, against access of the outside air. Opening the door increases also the speed of air by +1 or +2 levels, depending on user's preferences.



# Installation

Dedicated brackets and fixing points enable immediate installation of the curtain.

The maximum mounting height is 4m. The minimum distance between the air outlet of the curtain and the ceiling is only 30 cm.

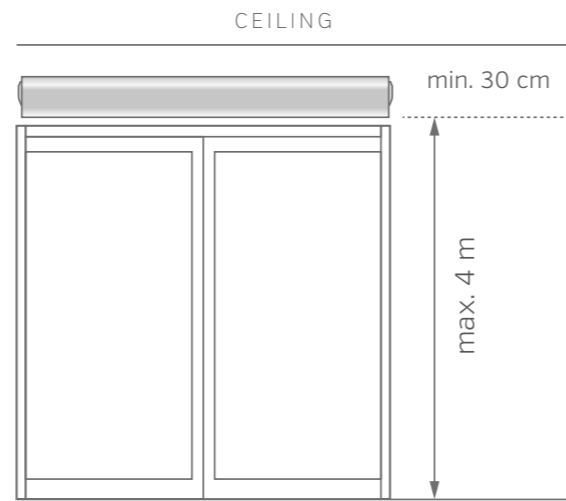
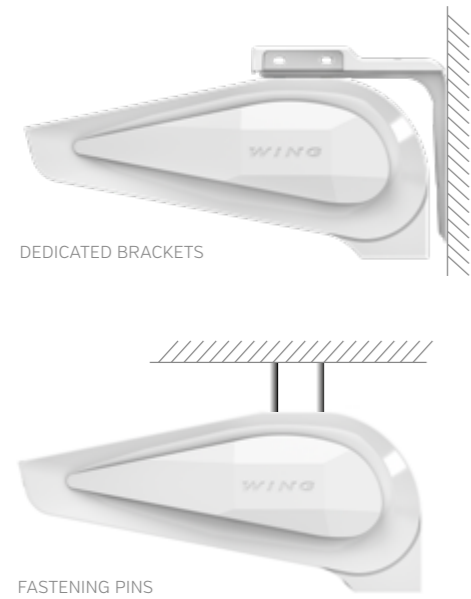

# INSTALLATION TEMPLATE

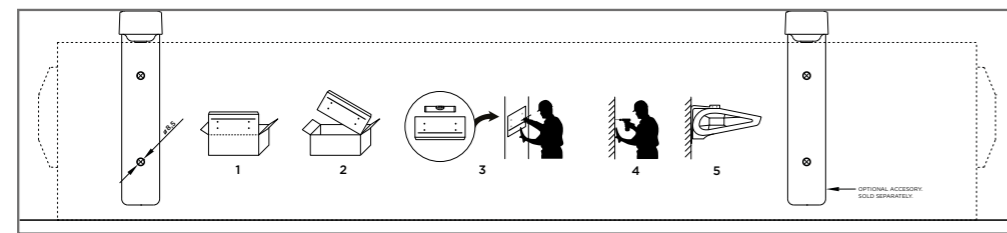

Each package of the WING Air Curtain comes with a template containing hole spacing and line levelling. All you need to do is to cut the template out of the cardboard lid and you are ready for the assembly.



# INSTALLATION EXAMPLE

Every WING Air Curtain can be mounted horizontally and vertically, except for electric. Electric is the only air curtain that cannot be mounted vertically. Due to the slim design, very small height of the housing and the inclined air inlet, the device may be mounted in a limited space above the door, without any effect on performance.

\* WING W, WING C



## HORIZONTAL INSTALLATION

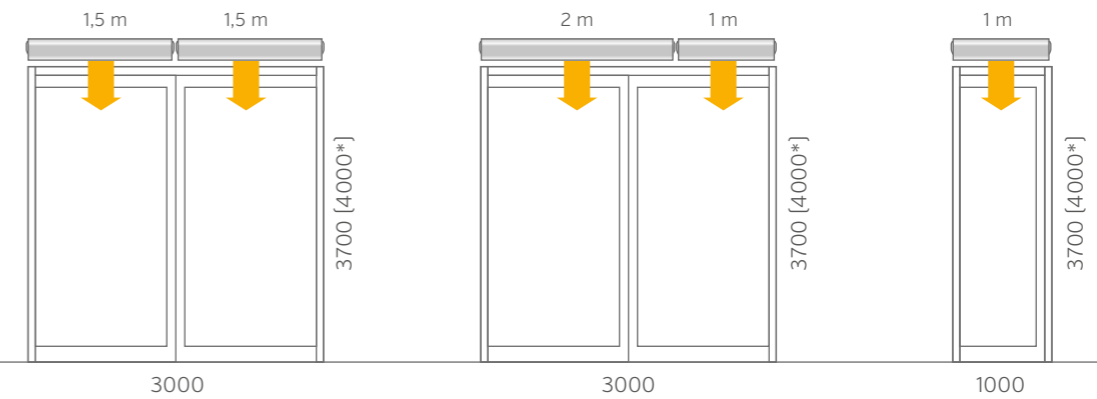

\*WING W, WING C

## VERTICAL INSTALLATION

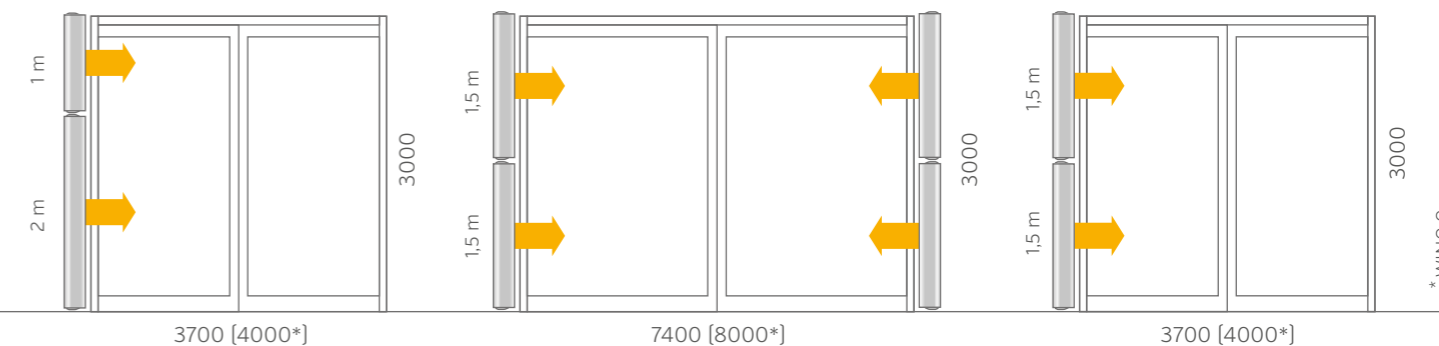

\* WING C

Electric curtain **cannot** be mounted vertically!

## SAMPLE CONNECTION DIAGRAM FOR THE AIR CURTAIN

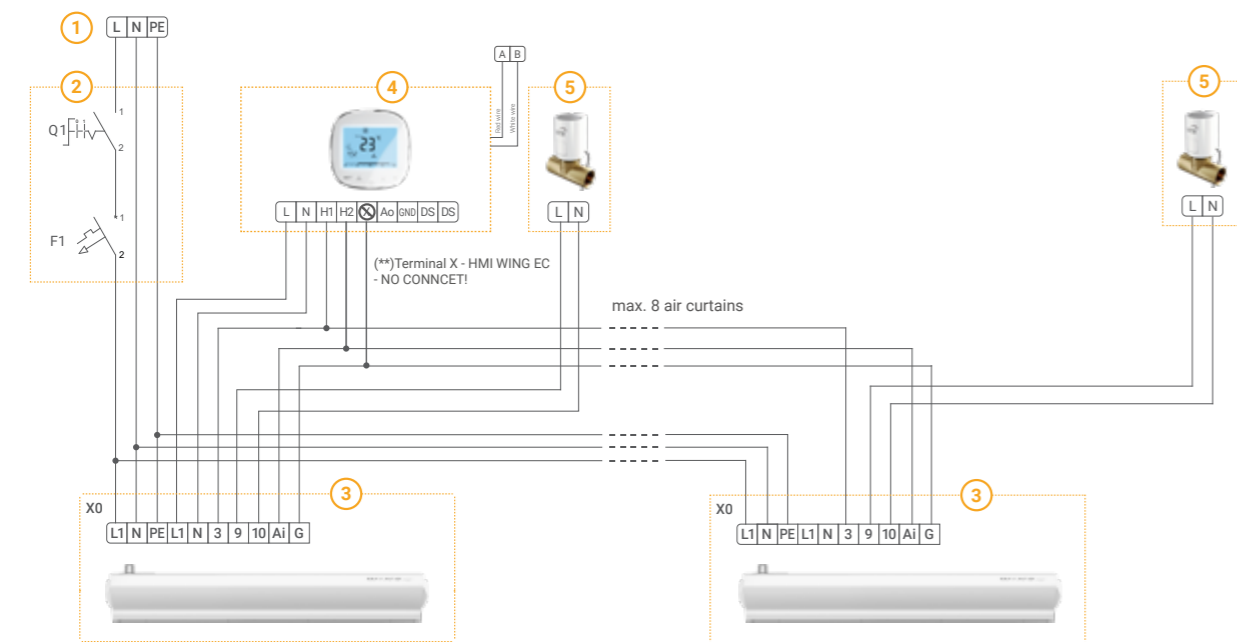
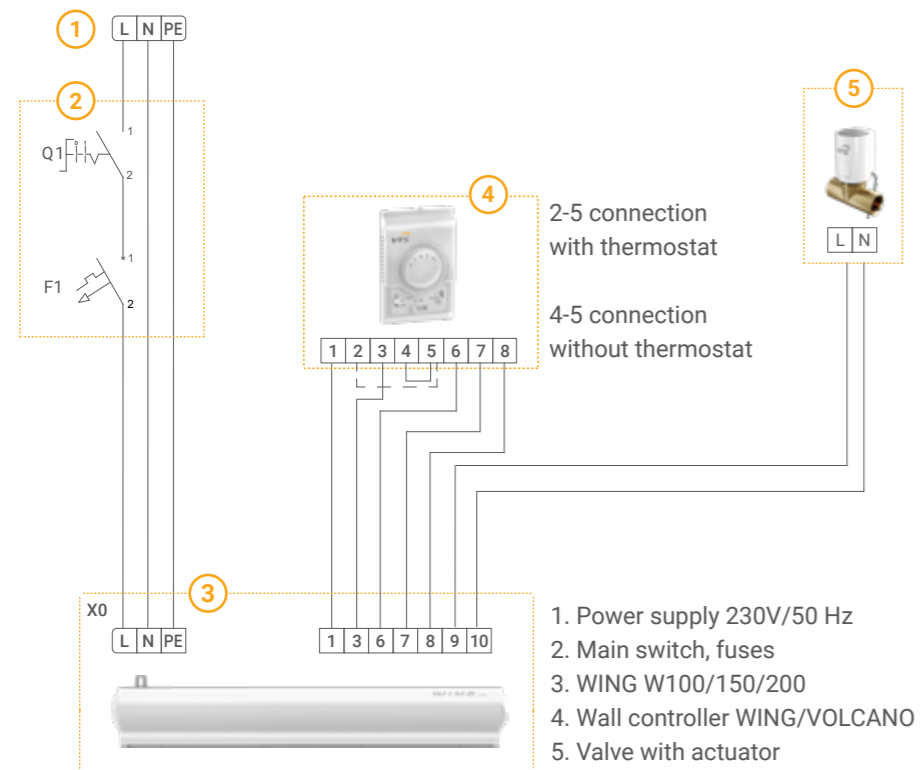

## TECHNICAL PARAMETERS

Parameters	Unit	WATER AIR CURTAIN						ELECTRIC AIR CURTAIN						AMBIENT AIR CURTAIN					
		WING W100		WING W150		WING W200		WING E100		WING E150		WING E200		WING C100		WING C150		WING C200	
		AC	EC	AC	EC	AC	EC	AC	EC	AC	EC	AC	EC	AC	EC	AC	EC	AC	EC
VTS article No.		1-4-2801-0035	1-4-2801-0055	1-4-2801-0036	1-4-2801-0056	1-4-2801-0037	1-4-2801-0057	1-4-2801-0038	1-4-2801-0058	1-4-2801-0039	1-4-2801-0059	1-4-2801-0040	1-4-2801-0060	1-4-2801-0041	1-4-2801-0061	1-4-2801-0042	1-4-2801-0062	1-4-2801-0043	1-4-2801-0063
maximum door width (1 device)	m	1		1,5		2		1		1,5		2		1		1,5		2	
maximum door height (vertical stream range)**	m			3,7						3,7						4			
maximum exhaustflow rate***	m³/h	1850		3100		4400		1850		3150		4500		1950		3200		4600	
heating power range:	kW	4-17		10-32		17-47		2/6 or 4/6		4/12 or 8/12		6/15 or 9/15		-		-		-	
maximum temperature of heating agent	°C			95						-						-		-	
maximum operating pressure	MPa			1,6						-						-		-	
water volume	dm³	1,6		2,6		3,6				-						-		-	
number of heat exchanger rows	pcs			2						-						-		-	
supply voltage	V/ph/Hz	~ 230/1/50						~230/1/50 for 2kW ~400/3/50 for 2/4/6kW		~400/3/50				~230/1/50					
electric heating coil power	kW	-						2 i 4		4 i 8		6 i 9		-					
electric heating coil current draw	A	-						max 9		6/11,3/max 17,3		8,5/12,9/max 21,4		-					
motor power	kW	0,235	0,2	0,375	0,3	0,58	0,45	0,235	0,2	0,375	0,3	0,58	0,45	0,235	0,2	0,375	0,3	0,58	0,45
rated current	A	1,2	1,1	1,7	1,3	2,6	1,9	1,2	1,1	1,7	1,3	2,6	1,9	1,2	1,1	1,7	1,3	2,6	1,9
weight (without water)	kg	23	21,5	32	29	39	37,5	23,5	22	32,5	30,5	41,5	39	20,5	19	27,5	25,5	34,5	32,5
protection rating	IP	20																	
casing colour		RAL 9016, outlet grid: RAL 9022																	

FAN SPEED	NOISE LEVEL	WING W100-200			WING E100-200			WING C100-200		
		1m	1,5m	2m	1m	1,5m	2m	1m	1,5m	2m
I	dB(A)***	52	53	56	49	51	55	53	54	57
II		55	58	61	51	56	59	59	62	61
III		57	59	62	58	58	60	62	63	63

\* available heating power in the control option configuration: Wing E100 2/6 kW or 4/6 kW, for Wing E150 4/12kW or 8/12kW, for Wing E200 6/15 kW or 9/15 kW  
\*\* air stream range depends on curtain operation speed  
\*\*\* measurement conditions: semi-open space, horizontal installation on the wall, measurement performed 5 m away from the device

ALL EC AIR CURTAINS ARE CHARACTERIZED BY EASE AND SIMPLICITY OF CONNECTION



# AIR CURTAINS WITH WATER HEATERS

## WING W100 (WATER AIR CURTAIN)

		Parameter $T_z/T_p$ [°C]															
		90/70 [°C]				80/60 [°C]				70/50 [°C]				60/40 [°C]			
		$Q_p$ [m³/h]	$P_g$ [kW]	$T_{p2}$ [°C]	$Q_w$ [m³/h]	$\Delta p$ [kPa]	$P_g$ [kW]	$T_{p2}$ [°C]	$Q_w$ [m³/h]	$\Delta p$ [kPa]	$P_g$ [kW]	$T_{p2}$ [°C]	$Q_w$ [m³/h]	$\Delta p$ [kPa]	$P_g$ [kW]	$T_{p2}$ [°C]	$Q_w$ [m³/h]
5	1850	17,7	32	0,78	0,5	14,8	28	0,65	0,4	11,6	22,8	0,51	0,2	8,0	17	0,35	0,1
	1350	15,0	35	0,66	0,4	12,5	30	0,55	0,3	9,8	24,4	0,43	0,2	5,4	16	0,23	0,1
	880	11,9	38	0,52	0,2	9,8	33	0,43	0,2	7,6	26,5	0,33	0,1	4,6	18	0,20	0,1
10	1850	16,2	35	0,72	0,4	13,3	31	0,59	0,3	10,2	25,8	0,45	0,2	5,0	18	0,22	0,1
	1350	13,8	38	0,61	0,3	11,3	33	0,50	0,2	8,5	27,2	0,37	0,1	4,6	19	0,20	0,1
	880	10,9	41	0,48	0,2	8,9	35	0,39	0,1	6,5	28,8	0,29	0,1	4,0	22	0,17	0,04
15	1850	14,9	39	0,66	0,4	11,9	34	0,52	0,2	8,7	28,7	0,38	0,1	4,3	22	0,19	0,04
	1350	12,6	41	0,56	0,3	10,1	36	0,44	0,2	7,2	29,7	0,32	0,1	3,9	23	0,17	0,04
	880	9,9	44	0,44	0,2	7,9	38	0,35	0,1	4,6	28,6	0,20	0,1	3,4	25	0,15	0,03
20	1850	13,5	42	0,59	0,3	10,5	37	0,46	0,2	7,0	31,3	0,31	0,1	3,5	26	0,15	0,03
	1350	11,4	44	0,50	0,2	8,8	38	0,90	0,1	4,7	29,7	0,20	0,1	3,2	27	0,14	0,03
	880	9,0	47	0,40	0,1	6,9	40	0,30	0,1	4,0	31,9	0,18	0,04	2,8	28	0,12	0,02

## WING W150 (WATER AIR CURTAIN)

		Parameter $T_z/T_p$ [°C]															
		90/70 [°C]				80/60 [°C]				70/50 [°C]				60/40 [°C]			
		$Q_p$ [m³/h]	$P_g$ [kW]	$T_{p2}$ [°C]	$Q_w$ [m³/h]	$\Delta p$ [kPa]	$P_g$ [kW]	$T_{p2}$ [°C]	$Q_w$ [m³/h]	$\Delta p$ [kPa]	$P_g$ [kW]	$T_{p2}$ [°C]	$Q_w$ [m³/h]	$\Delta p$ [kPa]	$P_g$ [kW]	$T_{p2}$ [°C]	$Q_w$ [m³/h]
5	3100	31,7	34	1,40	2,1	26,9	30	1,18	1,6	22,0	25	0,97	1,2	17,0	20	0,74	0,8
	2050	26,5	37	1,17	1,5	22,5	32	0,99	1,2	18,5	27	0,81	0,9	14,2	22	0,62	0,6
	1420	21,6	40	0,95	1,1	18,3	35	0,81	0,8	15,0	30	0,66	0,6	11,5	24	0,50	0,4
10	3100	29,3	37	1,29	1,8	24,5	33	1,08	1,4	19,6	28	0,86	1,0	14,5	23	0,64	0,6
	2050	24,5	40	1,08	1,3	20,5	35	0,90	1,0	16,5	30	0,72	0,7	12,1	25	0,53	0,4
	1420	19,9	43	0,88	0,9	16,7	38	0,73	0,7	13,4	32	0,59	0,5	9,8	26	0,43	0,3
15	3100	26,9	40	1,19	1,6	22,1	36	0,97	1,2	17,3	31	0,76	0,8	12,1	26	0,53	0,4
	2050	22,5	43	0,99	1,2	18,5	38	0,82	0,8	14,4	33	0,63	0,6	10,0	27	0,44	0,3
	1420	18,3	46	0,81	0,8	15,1	41	0,66	0,6	11,7	35	0,51	0,4	8,0	29	0,35	0,2
20	3100	24,5	44	1,08	1,3	19,8	39	0,87	0,9	14,9	34	0,65	0,6	9,5	29	0,41	0,3
	2050	20,5	46	0,91	1,0	16,6	41	0,73	0,7	12,4	36	0,54	0,4	7,7	30	0,34	0,2
	1420	16,7	49	0,74	0,7	13,5	43	0,59	0,5	10,1	37	0,44	0,3	4,8	28	0,21	0,1

## WING W200 (WATER AIR CURTAIN)

		Parameter $T_z/T_p$ [°C]															
		90/70 [°C]				80/60 [°C]				70/50 [°C]				60/40 [°C]			
		$Q_p$ [m³/h]	$P_g$ [kW]	$T_{p2}$ [°C]	$Q_w$ [m³/h]	$\Delta p$ [kPa]	$P_g$ [kW]	$T_{p2}$ [°C]	$Q_w$ [m³/h]	$\Delta p$ [kPa]	$P_g$ [kW]	$T_{p2}$ [°C]	$Q_w$ [m³/h]	$\Delta p$ [kPa]	$P_g$ [kW]	$T_{p2}$ [°C]	$Q_w$ [m³/h]
5	4400	46,9	35	2,04	5,6	39,4	30	1,73	4,3	32,6	26	1,43	3,2	25,7	21	1,12	2,2
	3150	40,9	37	1,81	4,5	35,0	32	1,54	3,5	28,9	27	1,27	2,6	22,8	23	1,00	1,8
	2050	34,0	40	1,50	3,2	29,0	35	1,28	2,5	24,1	30	1,05	1,9	19,0	24	0,83	1,3
10	4400	42,7	38	1,89	4,9	36,0	34	1,58	3,7	29,2	29	1,28	2,6	22,3	25	0,97	1,7
	3150	37,9	40	1,67	3,9	31,9	35	1,41	3,0	25,9	30	1,14	2,1	19,8	26	0,86	1,4
	2050	31,4	43	1,39	2,8	26,5	38	1,17	2,2	21,6	33	0,95	1,6	16,4	27	0,72	1,0
15	4400	39,3	41	1,73	4,2	32,6	37	1,43	3,1	25,8	32	1,13	2,1	18,9	28	0,82	1,3
	3150	34,8	43	1,54	3,4	28,9	38	1,27	2,5	22,9	33	1,01	1,7	16,7	28	0,73	1,0
	2050	28,9	46	1,28	2,4	24,0	41	1,06	1,8	19,1	35	0,84	1,2	13,9	30	0,61	0,7
20	4400	35,9	44	1,59	3,6	29,3	40	1,29	2,6	22,5	35	0,99	1,7	15,4	30	0,67	0,9
	3150	31,9	46	1,41	2,9	26,0	41	1,14	2,1	20,0	36	0,87	1,4	13,7	31	0,60	0,7
	2050	26,4	49	1,17	2,1	21,6	43	0,95	1,5	16,6	38	0,73	1,0	11,3	32	0,49	0,5

# AMBIENT AIR CURTAINS

## WING C100, C150, C200 (AMBIENT CURTAINS)

Parameter	WING C100			WING C150			WING C200		
	I	II	III	I	II	III	I	II	III
FAN SPEED									
$Q_p$ [m³/h]	1050	1500	1950	1500	2250	3200	2340	3400	4600
[dB(A)]*	53	59	62	54	62	63	57	61	63

\* measuring conditions: semi-open space, horizontal mounting on the wall, the measurement performed at the distance of 5m from the device

### LEGEND

- $T_z$  - water temperature at the inlet to the device
- $T_p$  - water temperature at the outlet from the device
- $T_{p1}$  - air temperature at the inlet to the device
- $T_{p2}$  - air temperature at the outlet from the device
- $P_g$  - heating power of the device
- $Q_p$  - air flow
- $Q_w$  - water flow
- $\Delta p$  - pressure drop in the heat exchanger



## AIR CURTAINS WITH ELECTRIC HEATER

### WING E100 (ELECTRIC AIR CURTAIN)

$T_{p1}$	$Q_p$ [m <sup>3</sup> /h]	$P_g$ [kW]	$T_{p2}$ [°C]
5	1850	2/4/6	8/11/15
	1400	2/4/6	9/12/16
	920	2/4/6	11/16/21
10	1850	2/4/6	13/16/20
	1400	2/4/6	14/17/21
	920	2/4/6	16/21/26
15	1850	2/4/6	18/21/25
	1400	2/4/6	19/22/26
	920	2/4/6	21/26/31
20	1850	2/4/6	23/26/30
	1400	2/4/6	24/27/31
	920	2/4/6	26/31/36

### WING E150 (ELECTRIC AIR CURTAIN)

$T_{p1}$	$Q_p$ [m <sup>3</sup> /h]	$P_g$ [kW]	$T_{p2}$ [°C]
5	3150	4/8/12	9/12/15
	2050	4/8/12	10/14/19
	1450	4/8/12	13/19/26
10	3150	4/8/12	14/17/20
	2050	4/8/12	15/19/24
	1450	4/8/12	18/24/31
15	3150	4/8/12	19/22/25
	2050	4/8/12	20/24/29
	1450	4/8/12	23/29/36
20	3150	4/8/12	24/27/30
	2050	4/8/12	25/29/34
	1450	4/8/12	28/34/41

### WING E200 (ELECTRIC AIR CURTAIN)

$T_{p1}$	$Q_p$ [m <sup>3</sup> /h]	$P_g$ [kW]	$T_{p2}$ [°C]
5	4500	6/9/15	9/10/14
	3200	6/9/15	10/12/16
	2150	6/9/15	12/15/21
10	4500	6/9/15	14/15/19
	3200	6/9/15	15/17/21
	2150	6/9/15	17/20/26
15	4500	6/9/15	19/20/24
	3200	6/9/15	20/22/26
	2150	6/9/15	22/25/31
20	4500	6/9/15	24/25/29
	3200	6/9/15	25/27/31
	2150	6/9/15	27/30/36

#### LEGEND

- $T_{p1}$  - air temperature at the inlet to the device
- $T_{p2}$  - air temperature at the outlet from the device
- $P_g$  - heating power of the device
- $Q_p$  - air flow

\* available heating capacities in the configuration of control options: Wing E100 2/6kW or 4/6kW, for Wing E150 4/12kW or 8/12kW. For Wing E200 6/15kW or 9/15kW



# FAQ

## 1. HOW TO CHOOSE A PROPER AIR CURTAIN?

The width of the air outlet from the air curtain should be wider than or equal to the width of the door opening. In order to ensure effective protection, set the fan speed to such a level that regardless of the mounting height, the air speed near the floor is not less than 2 m/s.

## 2. CAN ALL KINDS OF WING AIR CURTAINS BE MOUNTED IN A VERTICAL AND HORIZONTAL POSITION?

All devices, regardless of the length, are designed to be installed both ways: horizontally (WING W/E/C) and vertically (WING W/C). In the case of vertical installation it is possible to mount the motor pointing upwards or downwards. The mounting method does not affect system stability in any way. Please note that the air curtains with electrical heaters (WING E100-E200) are not suitable for vertical mounting.

## 3. HOW TO ADJUST THE ROTATIONAL SPEED OF THE WING CURTAIN DEPENDING ON THE EXPECTED MOUNTING HEIGHT?

Each model of WING curtains has three stages of fan speed forced by the controller.

## 4. WHAT ARE AMBIENT CURTAINS?

WING ambient curtains are air curtains without any function of air heating. Such curtains are not equipped with a water or electric heater. From the user's point of view this means that the temperature of the air stream at the curtain's outlet is equal to the temperature of the air drawn from the environment.

## 5. WHAT TEMPERATURE OF THE AIR AT THE INLET SHOULD BE TAKEN INTO ACCOUNT FOR CALCULATING THE HEATING POWER?

The air temperature prevailing in the room or the temperature to be set and maintained by other heating systems.

## 6. DO THE CONTROLLER WING AND WING EC HAVE THE POSSIBILITY OF ADJUSTING THE LEVEL OF THE CURTAIN'S HEATING POWER?

Yes. The controller Wing EC allows adjustment of heating power of the WING E. For WING W equipped with a valve it is possible to enable or disable function of heating. Without a valve, the heat exchanger remains in the free flow of the heating agent.

## 7. WHY IT IS NOT RECOMMENDED TO CONNECT THE DOOR SWITCH ALONG WITH THE VALVE AND ACTUATOR IN THE WING W CURTAIN?

When connecting a door sensor it is not recommended to use a valve with an actuator due to increased inertia of the system i.e. the heating time of the heat exchanger and the time it takes for the actuator to open the valve.

## 8. WHERE IN THE CASING OF THE WING CURTAIN ARE THE ELECTRIC CABLE GLANDS LOCATED?

The glands are located on the right side of the curtain behind the motor. The picture shows the placement of the cable grommets: no. 1 - grommet of the control cables, no. 2 - grommet of the supply lines, no. 3 - outlet grill of the motor.

## 9. CAN THE CONTROLLER WING BE CONNECTED TO ANY AMOUNT OF AIR CURTAINS?



Due to the contact load, the wall-mounted WING controller can be used to supply only one WING curtain. In order to control more curtains with a single controller, use an additional contactor in the power supply circuit of the curtains. For more detailed information, please consult VTS technical support department.

## 10. CAN THE AIR CURTAINS BE MOUNTED IN GROUPS?

Yes, it is possible to mount the curtains in groups, which enables the security of the door opening of any length (eg. 3 m, 3.5 m, 4 m, etc.).

## 11. CAN THE DOOR SENSOR OFFERED BY VTS BE CONNECTED TO ANY TYPE OF THE AIR CURTAIN?

The reed switch offered by VTS will be able to serve air curtains with EC motors only. There is a possibility to connect one reed switch to one controller WING EC. Controller can control up to 8 air curtains WING EC.

## 12. HOW TO PERFORM A PROPER VERTICAL MOUNTING OF THE DEVICE?



For vertical mounting use screws M8x70. Screw 2 or 3 handles through the flat washers to the threaded sleeves mounted at the top section of the housing. Keep a minimum distance of 10 cm from the floor in order to provide access to the water drain nozzles from the heat exchanger and the terminal strip.

## 13. ARE THE WING CURTAINS WITH EC MOTORS QUIETER THAN THOSE WITH AC MOTORS?

The noise generated by the air curtain is the result of the fan impeller operation and expeditious flow of air within the device. The motor itself, regardless of the type, generates very little noise, which is incomparably quieter than the noise of the impeller. Therefore, regardless of the motor type the difference in the noise generated by the entire device will be indistinguishable by the human ear.

## 14. WHAT IS THE MOUNTING HOLE SPACING?

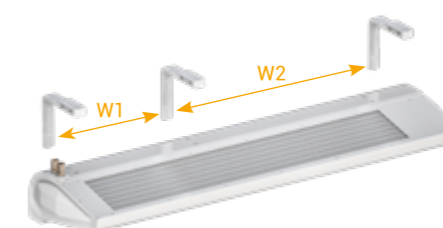

Curtain type	LxWxH [mm]
WING 100	1157 x 520 x 310
WING 150	1675 x 520 x 310
WING 200	2194 x 520 x 310

## 15. WHAT ARE THE DIMENSIONS OF THE DEVICE PACKAGE?

Curtain type	W1 [mm]	W2 [mm]
WING 100	772	-
WING 150	507	772
WING 200	921	910

## 16. WHAT TYPE OF WING CURTAINS ARE PACKED INTO THE PALLETS?

Curtain type	Pallet dimensions [mm]	Number of curtains on the pallet [pcs]
WING 100	1160x1040	10
WING 150	1680x1040	10
WING 200	2200x1040	8

## 17. CAN I FEED WING AIR CURTAIN WITH A NON-FREEZE MEDIUM?

Yes, you can. The most frequently used non-freeze medium is a water solution of ethylene glycol. The heaters mounted in WING can support up to 50% mixtures. Make sure to check, however, if other elements of the technological heat installation (valves, pump, etc.) are adapted to work on glycol mix. To do this, check the recommendations of the manufacturers of particular components used. Remember that the use of glycol mixes, which are usually characterized by higher viscosity and lower thermal capacity, compared to water, increases the resistance of heating medium flow and reduces the heating power of the device.



Check also in VTS offer

# VOLCANO

The Volcano heating units are a new generation of devices combining innovative technical solutions with a modern pattern design. Our precise and light casing resembles the beautiful diamond shape - ideal in its simplicity. The character of the device is emphasized by the composition of the selected materials and dynamically shaped air guide vanes.



VOLCANO	VR Mini	VR1	VR2	VR3	VR-D Mini	VR-D
HEATING POWER RANGE	3-20 kW	5-30 kW	8-50 kW	13-75 kW	-	-
MAXIMUM EXHAUST FLOW RATE*	2100 m <sup>3</sup> /h	5300 m <sup>3</sup> /h	4850 m <sup>3</sup> /h	5700 m <sup>3</sup> /h	2330 m <sup>3</sup> /h	6500 m <sup>3</sup> /h
HORIZONTAL RANGE (MAX.)	14 m	23 m	22 m	25 m	16 m	28 m
VERTICAL RANGE (MAX.)	8 m	12 m	11 m	12 m	10 m	15 m

\*0,5 m/s maximum speed

# VOLCANO EC

## Heating Unit

### EFFICIENT FANS

Optimized profile and increased blade surfaces provide for low maintenance costs and quiet operation.



### HMI VOLCANO EC CONTROLLER

- modern and compact design
- high contrast and clear screen
- advanced calendar for each day in the week
- ANTIFROST working mode
- BMS systems compatibility
- stepless fan speed regulation
- build-in thermostat and external temperature sensors cooperation
- valve with actuator connection possibility
- up to 8 heating units connected with the one controller

### ENERGY-SAVING REGULATION

EC motors guarantee maximum unit efficiency even at reduced speed. Stepless rotation regulation is now available for EC motors allowing the unit to adapt to any requirements.

### MATERIAL

Made of the highest class ABS with an anti-UV pigment mixture, the casing is characterized by high mechanical strength, durability, and resistance to high temperatures. The material provides for unchangeable aesthetics, easy to clean surfaces and long-term durability.

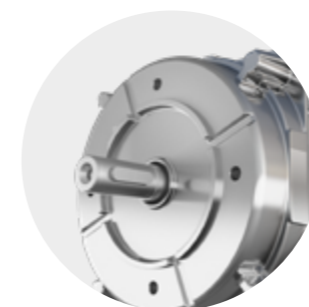



WATER HEATER

**VOLCANO**

STAY WARM

FOR MORE INFORMATION CONTACT OUR SALES TEAM  
OR VISIT [WWW.VTSGROUP.COM](http://WWW.VTSGROUP.COM)





VTS Plant Sp z o.o. | Olivia Tower, Al. Grunwaldzka 472A | 80-309 Gdańsk, Poland | Infolinia: 0 800 559 661 | [marketing@vtsgroup.com](mailto:marketing@vtsgroup.com)

[www.vtsgroup.com](http://www.vtsgroup.com)

The features mentioned are subject to continuous upgrade and can change any time. VTS assuring continuous improvement for product and data and reserves the right to change design and specifications without notice.