

Solo RA1-35-9 R V.2



The Solo ventilator is the most suitable solution for utility rooms, closets, and cloakrooms. Low power consumption will save electricity by providing clean and fresh air to any room with area of up to 25 m². The area is approximate and depends on the ventilation standards in your country and the model of the ventilator

- Air flow in heat recovery mode: 23
- Sound pressure level LpA at 3 m: 26
- Sound pressure level LpA at 1 m: 36
- Heat recovery efficiency: 85
- Filter: G3
- Motor type: EC
- Control: Remote Control
- Casing material: Plastic
- Humidity sensor

	Unit of measurement	Solo RA1-35-9 R V.2	
Speed	-	2	
Minimum supply voltage	V	220	
Maximum supply voltage	V	240	
Power supply frequency	Hz	50/60	
Rated power	W	1.50	2.30
Unit current	A	0.046	0.047
Air flow in ventilation mode	m ³ /h	30	46
Air flow in heat recovery mode	m ³ /h	15	23
Sound pressure level LpA at 3 m	dB(A)	21	26
Sound pressure level LpA at 1 m	dB(A)	31	36
Heat recovery efficiency	%	85	
Heat recovery efficiency, max	%	85	
Filter	-	G3	
Transported air temperature (max)	°C	40	
Transported air temperature (min)	°C	-15	
Ambient air temperature min	°C	1	
Ambient air temperature max	°C	40	
Ambient air humidity max	%	65	
Ingress protection rating	-	IP24	

Dimensions

$\varnothing D$	B	B1	L	L1	L2
107	150	153	305-380	35	69

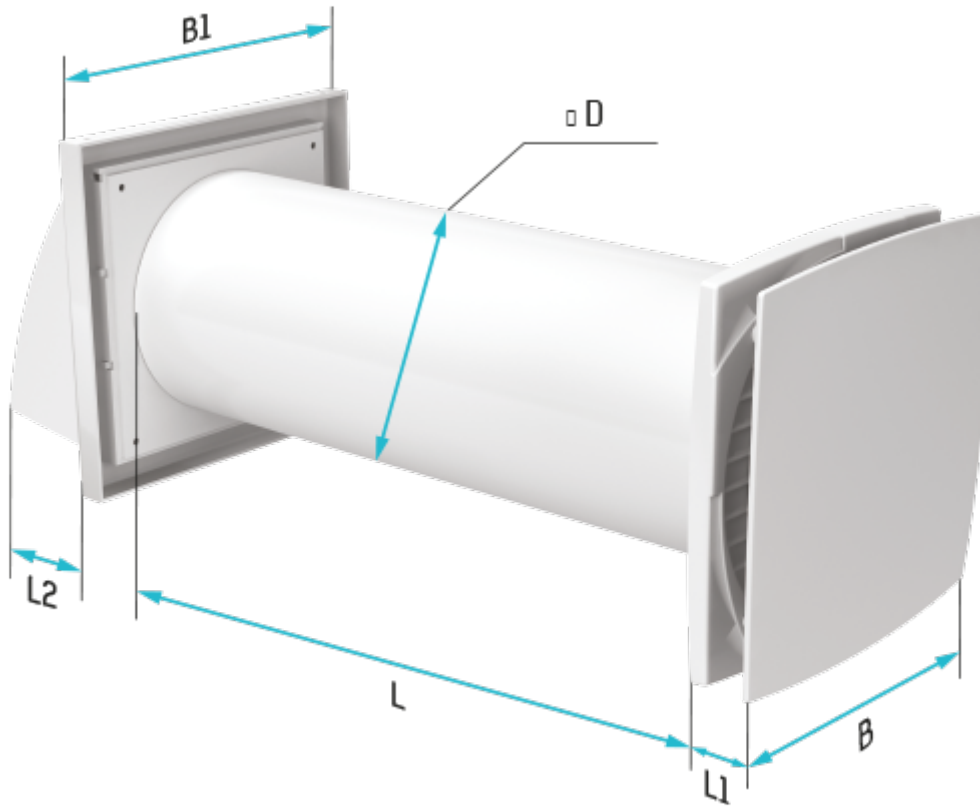

Ecodesign

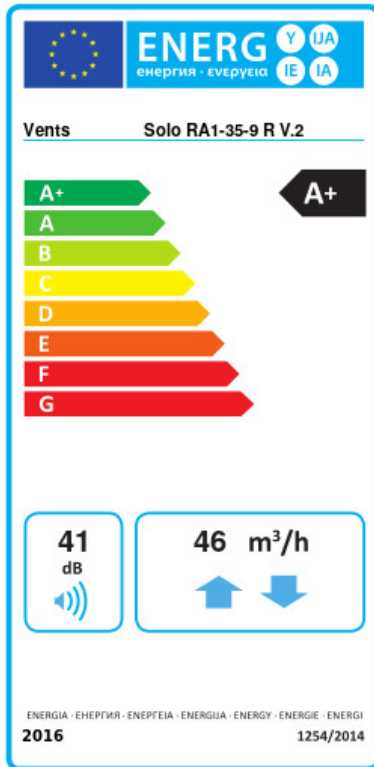

Trademark	Vents					
Model	Solo RA1-35-9 R V.2					
Specific energy consumption (SEC) (kWh/(m ² /a))	Cold		Average		Warm	
	-83.3	A+	-42.1	A+	-18.5	E
Type of ventilation unit	Bidirectional					
Type of drive installed	2-speed					
Type of heat recovery system	Regenerative					
Thermal efficiency of heat recovery (%)	74					
Maximum flow rate (m ³ /h)	46					
Electric power input (W)	2.3					
Reference flow rate (m ³ /s)	0.008					
Specific power input (SPI) (W/(m ³ /h))	0.05					
Control typology	Local demand control					
Airflow sensitivity at +20 Pa and -20 Pa (%)	0					
Declared typology	RVU BVU					
Sound power level (dB(A))	41					
The annual electricity consumption (AEC) (kWh/a)	Cold		Average		Warm	
	41		41		41	
The annual heating saved (AHS) (kWh/a)	Cold		Average		Warm	
	84		43		19	